

Product Specification				
	Model: XTPY50SN03-02	Rev. No.	Issued Date.	Page.
		A	2016,02,16	1 / 22

**Thin-Film-Transistor LCD Module
Model: XTPY50SN03-02**

Acceptance

Approved and Checked by

Approved by	Checked by		Made by

Product Specification				
	Model: XTPY50SN03-02	Rev. No.	Issued Date.	Page.
		A	2016,02,16	3 / 22

1. General Description and Features

XTPY50SN03-02 is a TM (Transmissive) type color active matrix TFT (Thin Film Transistor) liquid crystal display (LCD) that uses amorphous silicon TFT as a switching device. This model is composed of a TFT-LCD module, a driver circuit and a back-light unit . The resolution of a 5" contains 480RGBx272 dots The following table described the features of XTPY50SN03-02.

1.1 LCD Module

Item	Specification	Unit
Screen Size	5.0 inches	Diagonal
Display Resolution	480 x RGB x 272	Dot
Active Area	110.88 (H) x 62.83 (V)	mm
Outline Dimension	120.7(W) x 75.8(H) x 2.7 (D)	mm
Display Mode	Normally white/Transmissive	--
Pixel Arrangement	RGB-Stripe	--
Surface Treatment	Anti-glare (AG)	--
Viewing Direction	12 o'clock	--
Input Interface	Digital	--
LED Life	50000 Hours	

Product Specification				
	Model: XTPY50SN03-02	Rev. No.	Issued Date.	Page.
		A	2016,02,16	4 / 22

2. Mechanical Information

Item	Min.	Typ.	Max.	Unit	Note	
Module Size	Horizontal (H)	--	120.7	--	mm	--
	Vertical (V)	--	75.8	--	mm	(1)
	Thickness (T)	--	2.7	--	mm	(2)
Weight	--	N/A	--	g	--	

Note (1) Not include FPC.

Refer to the Outline Dimension for further information.

(2) Back-light unit are included.

3. Electrical Specifications

3.1 Absolute Max. Ratings

3.1.1 Absolute Ratings of Environment

If the operating condition exceeds the following absolute maximum ratings, the TFT LCD module may be damaged permanently.

($T_a=25\pm 2^{\circ}\text{C}$, $V_{SS}=\text{GND}=0$)

Item	Symbol	Min.	Max.	Unit	Note
Storage temperature	T_{STG}	-30	80	$^{\circ}\text{C}$	(1)
Operating temperature	T_{OPR}	-20	70	$^{\circ}\text{C}$	(1,2,3)

Note (1) 95 % RH Max. ($40^{\circ}\text{C} \geq T_a$). Maximum wet-bulb temperature at 39°C or less. ($T_a > 40^{\circ}\text{C}$) No condensation.

Note (2) In case of below 0° , the response time of liquid crystal (LC) becomes slower and the color of panel becomes darker than normal one. Level of retardation depends on temperature, because of LC's character

Note (3) Only operation is guaranteed at operating temperature. Contrast, response time, another display quality are evaluated at $+25^{\circ}\text{C}$.

Product Specification				
	Model: XTPY50SN03-02	Rev. No.	Issued Date.	Page.
		A	2016,02,16	5 / 22

3.2 Electrical Absolute Rating

3.2.1 TFT-LCD Module

(Voltage Referenced to VSS)

Item	Symbol	Value		Unit	Condition
		Min.	Max.		
Digital Power Supply Voltage	VDD	VSS-0.5	5.0	V	--

3.2.2 Back-Light Unit

(Ta=25±2°C)

Item	Symbol	Min.	Type.	Unit	Note
current	I _f	--	40	mA	(1)
voltage	V _R	--	16	V	(1)

Note (1) Permanent damage to the device may occur if maximum values are exceeded or reverse voltage is loaded. Functional operation should be restricted to the conditions described under normal operating conditions.

Product Specification

	Model: XTPY50SN03-02	Rev. No.	Issued Date.	Page.
		A	2016,02,16	6 / 22

4 PinAssignment

4-1 LCM PIN

Pin No.	Symbol	I/O	Functi	Remark
1	VLED-	P	Power for LED backlight (Cathode)	
2	VLED+	P	Power for LED backlight (Anode)	
3	GND	P	Power ground	
4	VDD	P	Power supply	
5	R0	I	Data bus	
6	R1	I	Data bus	
7	R2	I	Data bus	
8	R3	I	Data bus	
9	R4	I	Data bus	
10	R5	I	Data bus	
11	R6	I	Data bus	
12	R7	I	Data bus	
13	G0	I	Data bus	
14	G1	I	Data bus	
15	G2	I	Data bus	
16	G3	I	Data bus	
17	G4	I	Data bus	
18	G5	I	Data bus	
19	G6	I	Data bus	
20	G7	I	Data bus	
21	B0	I	Data bus	
22	B1	I	Data bus	
23	B2	I	Data bus	
24	B3	I	Data bus	
25	B4	I	Data bus	
26	B5	I	Data bus	
27	B6	I	Data bus	
28	B7	I	Data bus	
29	GND	P	Power ground	

Product Specification

	Model: XTPY50SN03-02	Rev. No.	Issued Date.	Page.
		A	2016,02,16	7 / 22

30	DCLK	I	Dot clock	
31	DISP	I	Display on/off	
32	HSYN	I	Horizontal signal YNC	
33	VSYN	I	Vertical signal YNC	
34	DE	I	Data enable	
35	NC	-	No connect	
36	GND	P	Power Ground	
37	XR	I	TP pin	
38	YD	I	TP pin	
39	XL	I	TP pin	
40	YU	I	TP pin	

Product Specification				
Model: XTPY50SN03-02	Rev. No.	Issued Date.	Page.	
	A	2016,02,16	8 / 22	

5 Operation specification

Item	Symbol	Min	Typ	Max	Unit	Applicable terminal
Supply voltage for logic	V_{cc}	3	3.3	3.6	V	V_{DD}
Input voltage	V_{IL}	-0.3	-	$0.2 V_{DD}$	V	
	V_{IH}	$0.8 V_{cc}$	-	V_{cc}	V	
Input leakage current	I_{LKG}				μA	
LED Forward voltage	V_f	3.0	3.2	3.4	V	With One LED
Input backlight current	I_{LED}	-	20	25	mA	With One LED

6 Power sequence

Power on:

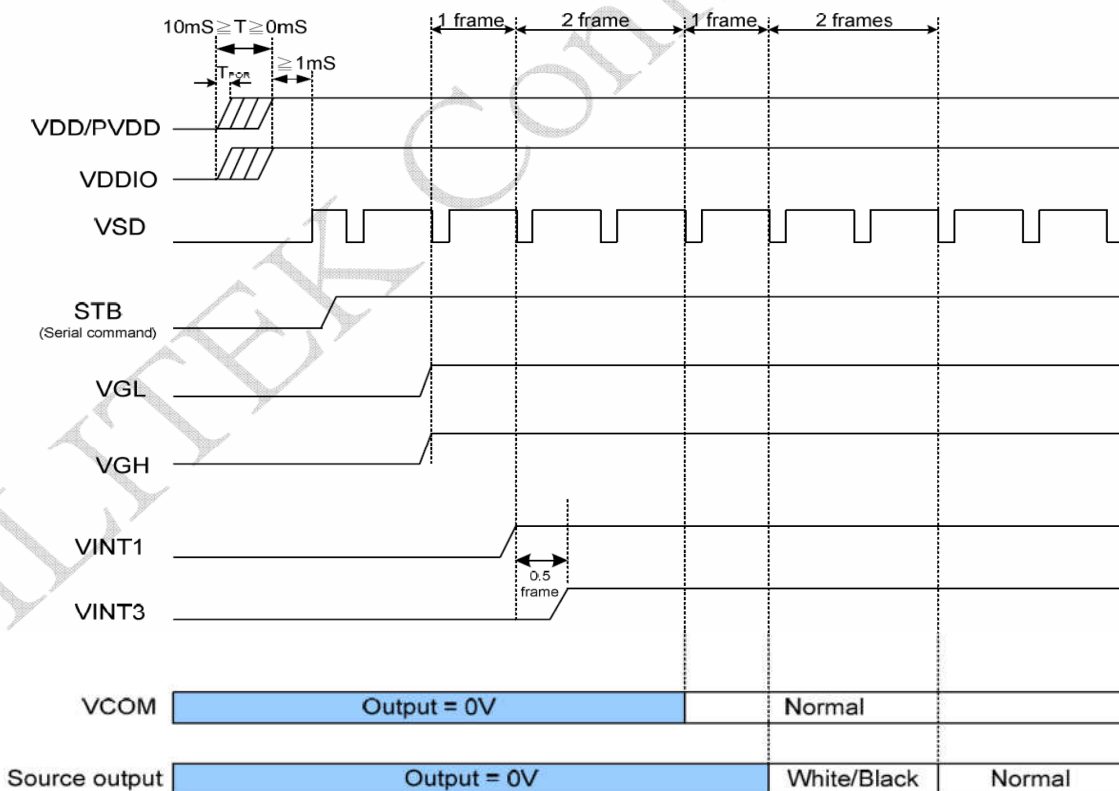

Product Specification

	Model: XTPY50SN03-02	Rev. No.	Issued Date.	Page.
		A	2016,02,16	9 / 22

Power off:

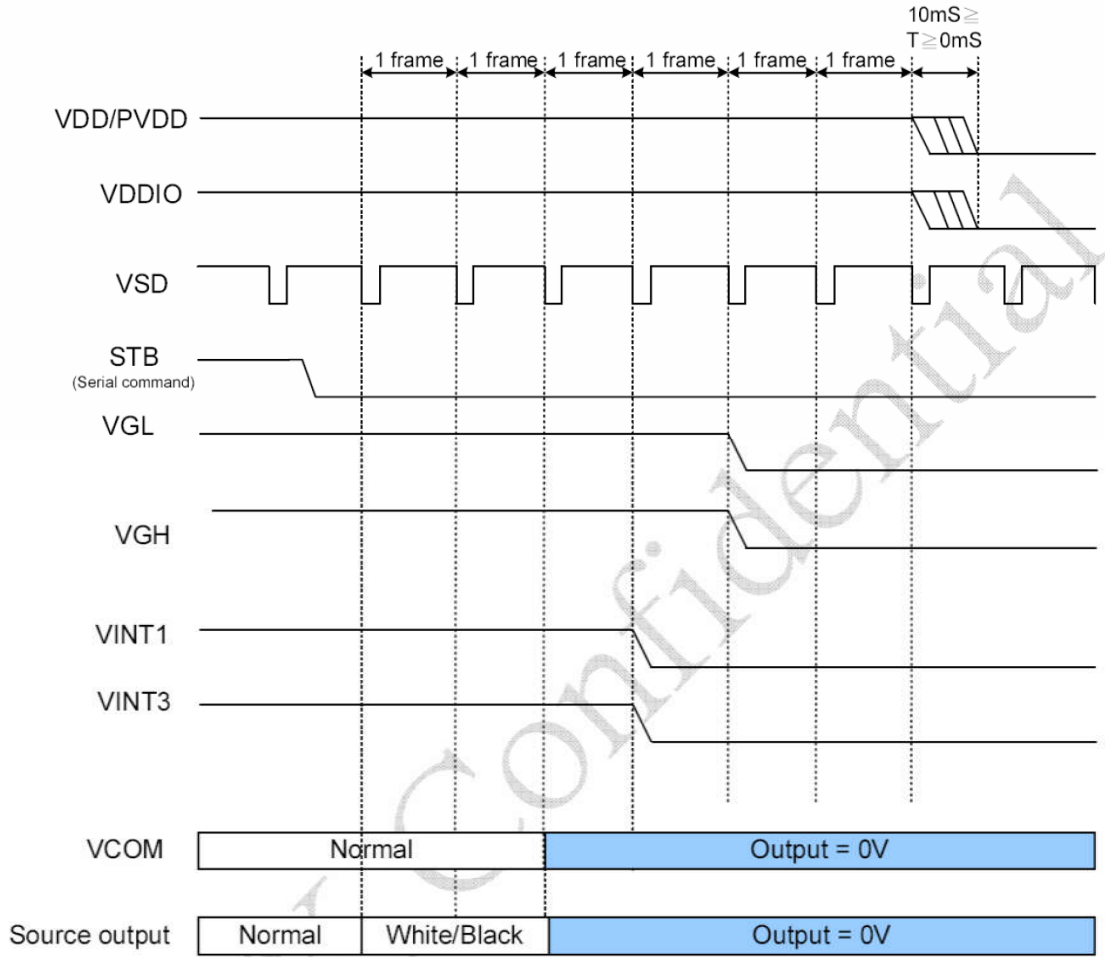

Product Specification

	Model: XTPY50SN03-02	Rev. No.	Issued Date.	Page.
		A	2016,02,16	10 / 22

7 Timing characteristics

Parallel RGB input timign table

Parameter	Symbol	Value			Unit
		Min.	Typ.	Max.	
DCLK frequency	fclk	5	9	12	MHz
VSD period time	Tv	277	288	400	H
VSD display area	Tvd	272			H
VSD back porch	Tvb	3	8	31	H
VSD front porch	Tvfp	2	8	97	H
HSD period time	Th	520	525	800	DCLK
HSD display area	Thd	480			DCLK
HSD back porch	Thbp	36	40	255	DCLK
HSD front porch	Thfp	4	5	65	DCLK

Parameters	Symbol	Min.	Typ.	Max.	Unit	Conditions
DCLK frequency	Fclk	24	27	30	MHz	
DCLK cycle time	Tclk	83	110	200	ns	
DCLK pulse duty	Tcwh	40	50	60	%	
Time from HSD to source output	Thso	-	13	-	DCLK	
Time from HSD to gate output	Thgo	-	27	-	DCLK	
Time from HSD to gate output off	Thgz	-	3	-	DCLK	
Time from HSD to VCOM	Thvc	-	12	-	DCLK	

Product Specification				
	Model: XTPY50SN03-02	Rev. No.	Issued Date.	Page.
		A	2016,02,16	11 / 22

Data Input Format

Parallel RGB mode data format

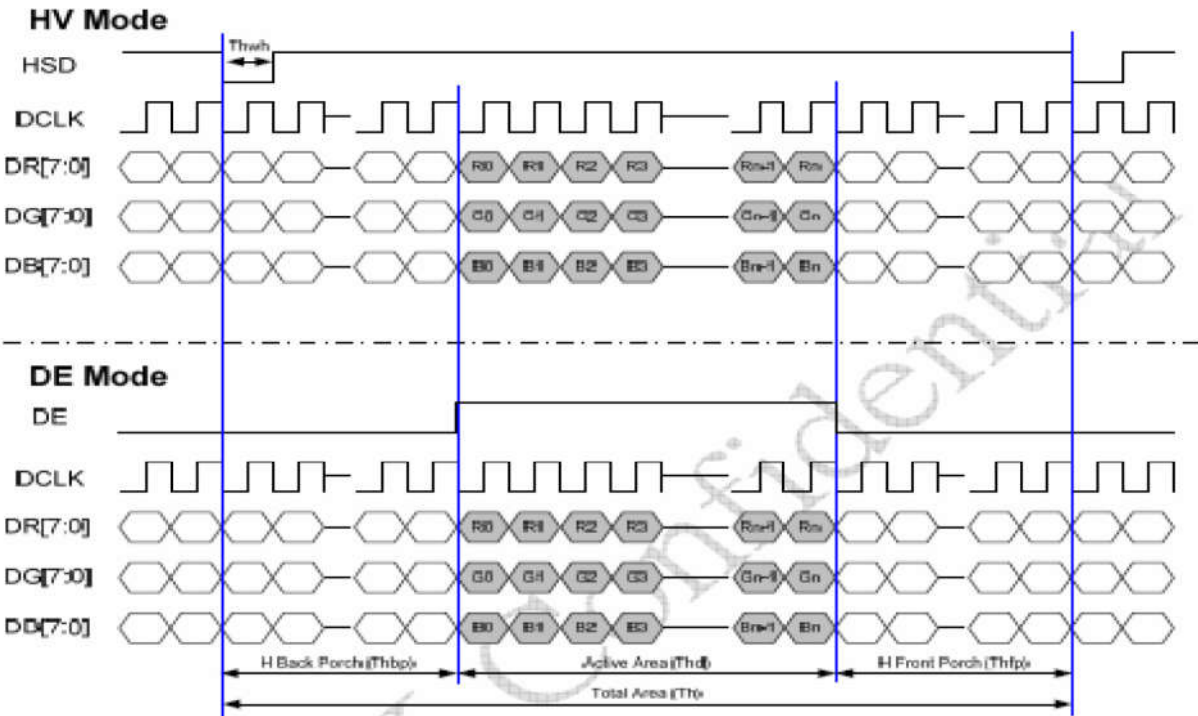

Product Specification				
	Model: XTPY50SN03-02	Rev. No.	Issued Date.	Page.
		A	2016,02,16	12 / 22

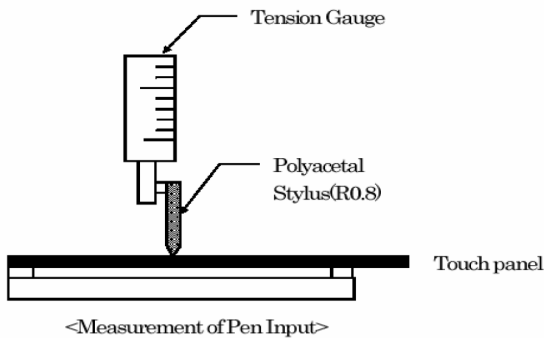

Note 2: Measurement for surface area.

- Scratch 100,000 times straight line on the film with a stylus change every 20,000 times.
- Force: 250gf.
- Speed: 60mm/sec.
- Stylus: R0.8 polyacetal tip.

Note 3: Pit 1,000,000 times on the film with a R0.8 silicon rubber.

- Force: 250gf.
- Speed: 2times/sec.

Linearity Definition

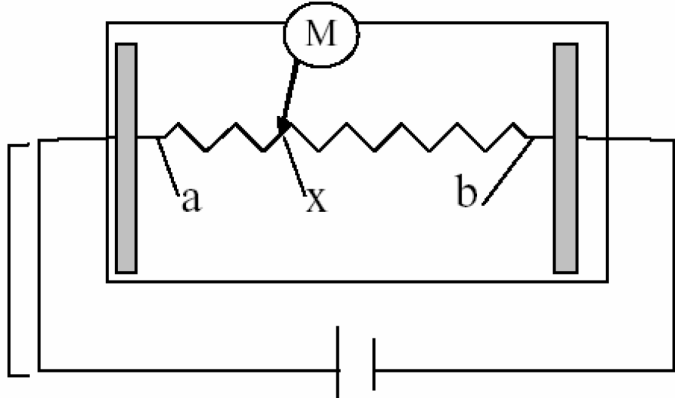

- Va: maximum voltage in the active area of touch panel
- Vb: minimum voltage in the active area of touch panel
- X: random measuring point
- Vxm: actual voltage of Lx point
- Vxi: theoretical voltage of Lx point

Product Specification			
	Model: XTPY50SN03-02	Rev. No.	Issued Date.
		A	2016,02,16
			Page. 13 / 22

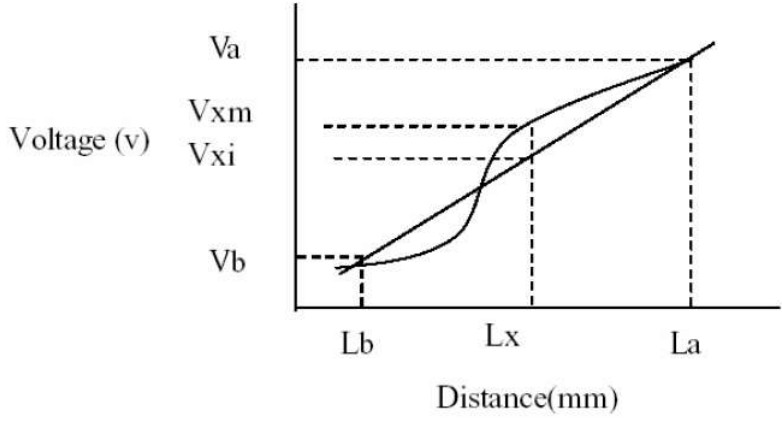

Linearity= $[(V_{xi}-V_{xm})/(V_a-V_b)]*100\%$

Note: Test area is as follows and operation force is 150gf

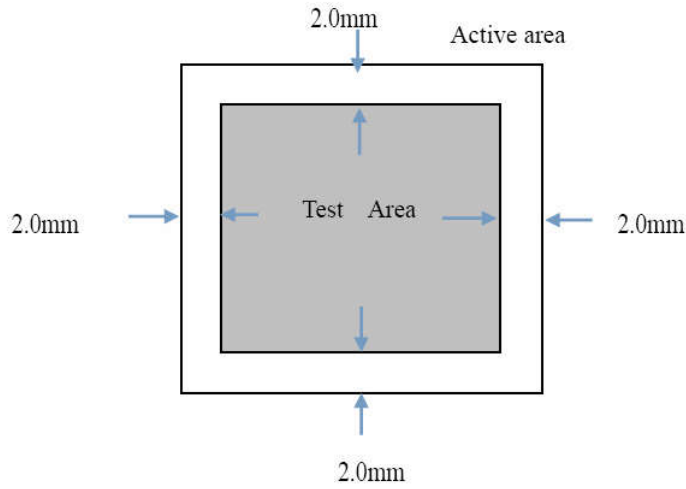

Product Specification

	Model: XTPY50SN03-02	Rev. No.	Issued Date.	Page.
		A	2016,02,16	14 / 22

8 Optical Specification

ITEM	SYMBOL	CONDITIONS	SPECIFICATIONS			UNIT	NOTE	
			MIN.	TYP.	MAX			
Brightness	B	Viewing normal angle	-	200	-	Cd/m ²	All left side data are based on CPT's product reference only	
Contrast Ratio	CR		350	500	--	--		
Response Time	Tr+Tf		--	30		ms		
CIE Color coordinate	Red		X_R	--	0.608			
			Y_R		0.316			
	Green		X_G	--	0.305			
			Y_G		0.556			
	Blue		X_B	--	0.135			
			Y_B		0.137			
White	X_w		--	0.300				
	Y_w		0.340					
Viewing Angle	Hor.	θ_{x+}	55	65	--	Deg.		
		θ_{x-}	55	65	--			
	Ver.	θ_{y+}	45	55	--			
		θ_{y-}	45	55				
Uniformity	Un		80	85		%		

Product Specification				
	Model: XTPY50SN03-02	Rev. No.	Issued Date.	Page.
		A	2016,02,16	15 / 22

Note 1: Definition of viewing angle range

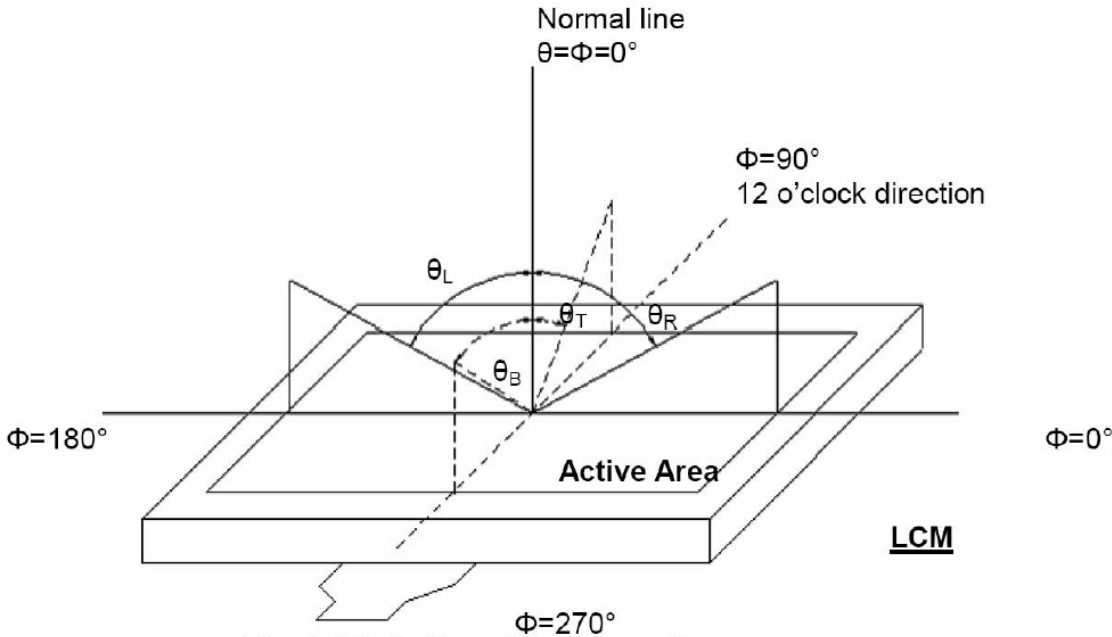

Fig. 4-1 Definition of viewing angle

Note 2: Definition of optical measurement system.

The optical characteristics should be measured in dark room. After 30 minutes operation, the optical properties are measured at the center point of the LCD screen. (Response time is measured by Photo detector TOPCON BM-7, other items are measured by BM-5A/Field of view: 1° /Height: 500mm.)

Product Specification				
	Model: XTPY50SN03-02	Rev. No.	Issued Date.	Page.
		A	2016,02,16	16 / 22

9 Reliability Condition for LCD

No change on display and in operation under the following test condition.

Condition: Unless otherwise specified, tests will be conducted under the following condition.

Temperature: 20±5°C Humidity: 65±5%RH

Tests will be not conducted under functioning state.

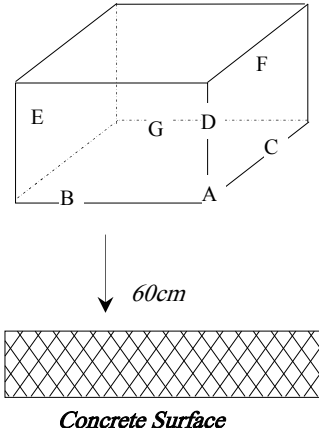
No.	Parameter	Condition	Notes
1	High Temperature Operating	80°C±2°C, 240hrs (Operation state)	--
2	Low Temperature Operating	-30°C±2°C, 240hrs (Operation state)	--
3	High Temperature Storage	80°C±2°C, 240hrs	--
4	Low Temperature Storage	-30°C±2°C, 240hrs	--
5	High Temperature and High Humidity Operation Test	60°C±2°C, 90%, 240hrs	--
6	Vibration Test	Total fixed amplitude: 1.5mm Vibration Frequency: 10±55Hz One cycle 60 seconds to 3 direction of X, Y, Z each 15 minutes.	--
7.	Drop Test	To be measured after dropping from 60cm high on the concrete surface in packing state.  <p><i>Dropping method corner dropping</i> A corner: once <i>Edge dropping</i> B, C, D edge: once <i>Face dropping</i> E, F, G face: once</p> <p><i>Concrete Surface</i></p>	--

- Notes:
1. No dew condensation to be observed.
 2. The function test shall be conducted after 4 hours storage at the normal temperature and humidity after removed from the test chamber.
 3. Vibration test will be conducted to the product itself without putting I in a container.

Product Specification				
	Model: XTPY50SN03-02	Rev. No.	Issued Date.	Page.
		A	2016,02,16	17 / 22

10 Incoming Inspection Standards

10.1 VISUAL & FUNCTION INSPECTION STANDARD

Inspection performed under the following conditions is recommended.

Temperature : $25 \pm 5^\circ\text{C}$

Humidity : $65\% \pm 10\% \text{RH}$

Viewing Angle : Normal viewing Angle.

Illumination: Single fluorescent lamp (300 to 700Lux)

Viewing distance:30-50cm

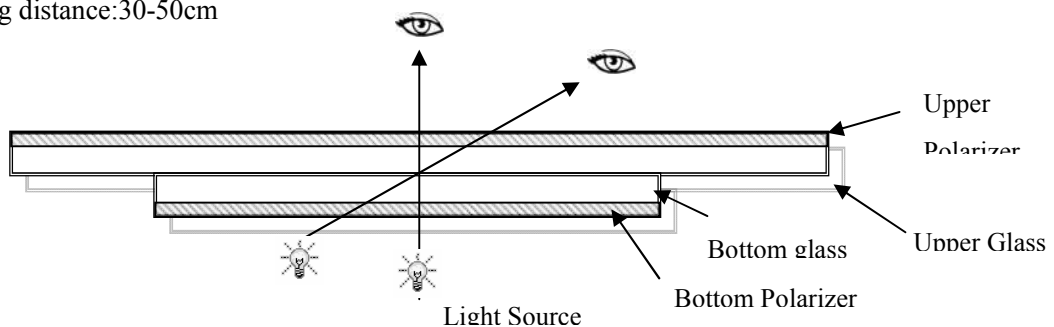

10.2 Definition

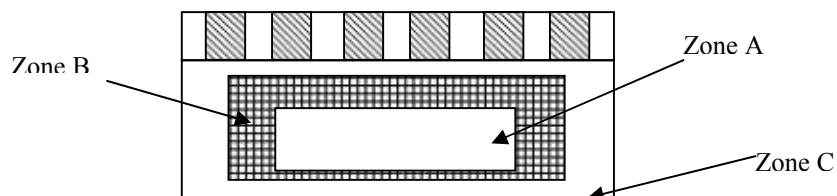

Zone A : Effective Viewing Area(Character or Digit can be seen)

Zone B : Viewing Area except Zone A

Zone C : Outside (Zone A+Zone B) which can not be seen after assembly by customer .)

Note:

As a general rule ,visual defects in Zone C can be ignored when it doesn't effect product function

or appearance after assembly by customer.

Product Specification				
	Model: XTPY50SN03-02	Rev. No.	Issued Date.	Page.
		A	2016,02,16	18 / 22

10.3 Sampling Plan

According to GB/T 2828-2003 ; , normal inspection, Class II

AQL:

Major defect	Minor defect
0.65	1.5

LCD: Liquid Crystal Display , TP: Touch Panel , LCM: Liquid Crystal Module

No	Items to be inspected	Criteria	Classification of defects
1	Functional defects	1) No display, Open or miss line 2) Display abnormally, Short 3) Backlight no lighting, abnormal lighting. 4) TP no function	Major
2	Missing	Missing component	
3	Outline dimension	Overall outline dimension beyond the drawing is not allowed	
4	Color tone	Color unevenness, refer to limited sample	Minor
5	Soldering appearance	Good soldering , Peeling off is not allowed.	
6	LCD/Polarizer/TP	Black/White spot/line, scratch, crack, etc.	

10.4 Criteria (Visual)

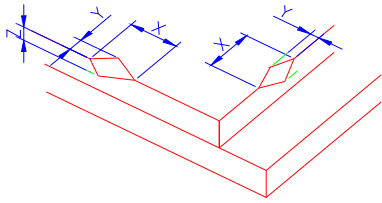
Number	Items	Criteria(mm)						
1.0 LCD Crack/Broken	(1) The edge of LCD broken	 <table border="1" data-bbox="868 1666 1410 1823"> <thead> <tr> <th>X</th> <th>Y</th> <th>Z</th> </tr> </thead> <tbody> <tr> <td>≤3.0mm</td> <td><Inner border line of the seal</td> <td>≤T</td> </tr> </tbody> </table>	X	Y	Z	≤3.0mm	<Inner border line of the seal	≤T
X	Y	Z						
≤3.0mm	<Inner border line of the seal	≤T						
NOTE: X: Length Y: Width								

Product Specification

	Model: XTPY50SN03-02	Rev. No.	Issued Date.	Page.
		A	2016,02,16	19 / 22

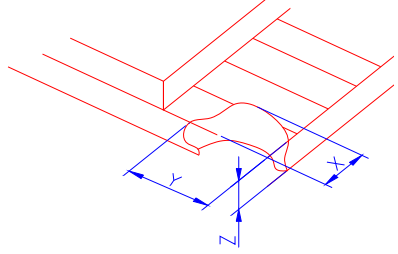
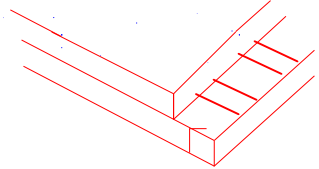
<p>Z: Height L: Length of ITO, T: Height of LCD</p>	<p>(2)LCD corner broken</p>	 <table border="1" style="margin: 10px auto; border-collapse: collapse;"> <tr> <td style="text-align: center;">X</td> <td style="text-align: center;">Y</td> <td style="text-align: center;">Z</td> </tr> <tr> <td style="text-align: center;">$\leq 3.0\text{mm}$</td> <td style="text-align: center;">$\leq L$</td> <td style="text-align: center;">$\leq T$</td> </tr> </table>	X	Y	Z	$\leq 3.0\text{mm}$	$\leq L$	$\leq T$
X	Y	Z						
$\leq 3.0\text{mm}$	$\leq L$	$\leq T$						
	<p>(3) LCD crack</p>	 <p style="text-align: center;">Crack Not allowed</p>						

Product Specification

	Model: XTPY50SN03-02	Rev. No.	Issued Date.	Page.
		A	2016,02,16	20 / 22

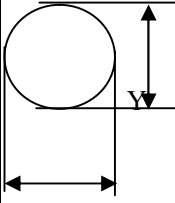
Number	Items	Criteria (mm)																																																																	
2.0	Spot defect  $\Phi = (X+Y)/2$	① light dot (LCD/TP/Polarizer black/white spot , light dot, pinhole, dent, stain) <table border="1" style="width: 100%; border-collapse: collapse;"> <thead> <tr> <th rowspan="2" style="width: 20%;">Zone Size (mm)</th> <th colspan="3">Acceptable Qty</th> </tr> <tr> <th style="width: 15%;">A</th> <th style="width: 15%;">B</th> <th style="width: 15%;">C</th> </tr> </thead> <tbody> <tr> <td>$\Phi \leq 0.10$</td> <td colspan="3" style="text-align: center;">Ignore</td> </tr> <tr> <td>$0.10 < \Phi \leq 0.15$</td> <td colspan="3" style="text-align: center;">3(distance $\geq 10\text{mm}$)</td> </tr> <tr> <td>$0.15 < \Phi \leq 0.2$</td> <td colspan="3" style="text-align: center;">1</td> </tr> <tr> <td>$0.2 < \Phi$</td> <td colspan="3" style="text-align: center;">0</td> </tr> </tbody> </table> ② Dim spot (LCD/TP/Polarizer dim dot, light leakage、 dark spot) <table border="1" style="width: 100%; border-collapse: collapse;"> <thead> <tr> <th rowspan="2" style="width: 20%;">Zone Size (mm)</th> <th colspan="3">Acceptable Qty</th> </tr> <tr> <th style="width: 15%;">A</th> <th style="width: 15%;">B</th> <th style="width: 15%;">C</th> </tr> </thead> <tbody> <tr> <td>$\Phi \leq 0.1$</td> <td colspan="3" style="text-align: center;">Ignore</td> </tr> <tr> <td>$0.1 < \Phi \leq 0.2$</td> <td colspan="3" style="text-align: center;">2(distance $\geq 10\text{mm}$)</td> </tr> <tr> <td>$0.2 < \Phi \leq 0.3$</td> <td colspan="3" style="text-align: center;">1</td> </tr> <tr> <td>$\Phi > 0.3$</td> <td colspan="3" style="text-align: center;">0</td> </tr> </tbody> </table> ③ Polarizer accidented spot <table border="1" style="width: 100%; border-collapse: collapse;"> <thead> <tr> <th rowspan="2" style="width: 20%;">Zone Size (mm)</th> <th colspan="3">Acceptable Qty</th> </tr> <tr> <th style="width: 15%;">A</th> <th style="width: 15%;">B</th> <th style="width: 15%;">C</th> </tr> </thead> <tbody> <tr> <td>$\Phi \leq 0.2$</td> <td colspan="3" style="text-align: center;">Ignore</td> </tr> <tr> <td>$0.2 < \Phi \leq 0.5$</td> <td colspan="3" style="text-align: center;">2(distance $\geq 10\text{mm}$)</td> </tr> <tr> <td>$\Phi > 0.5$</td> <td colspan="3" style="text-align: center;">0</td> </tr> </tbody> </table>	Zone Size (mm)	Acceptable Qty			A	B	C	$\Phi \leq 0.10$	Ignore			$0.10 < \Phi \leq 0.15$	3(distance $\geq 10\text{mm}$)			$0.15 < \Phi \leq 0.2$	1			$0.2 < \Phi$	0			Zone Size (mm)	Acceptable Qty			A	B	C	$\Phi \leq 0.1$	Ignore			$0.1 < \Phi \leq 0.2$	2(distance $\geq 10\text{mm}$)			$0.2 < \Phi \leq 0.3$	1			$\Phi > 0.3$	0			Zone Size (mm)	Acceptable Qty			A	B	C	$\Phi \leq 0.2$	Ignore			$0.2 < \Phi \leq 0.5$	2(distance $\geq 10\text{mm}$)			$\Phi > 0.5$	0		
Zone Size (mm)	Acceptable Qty																																																																		
	A	B	C																																																																
$\Phi \leq 0.10$	Ignore																																																																		
$0.10 < \Phi \leq 0.15$	3(distance $\geq 10\text{mm}$)																																																																		
$0.15 < \Phi \leq 0.2$	1																																																																		
$0.2 < \Phi$	0																																																																		
Zone Size (mm)	Acceptable Qty																																																																		
	A	B	C																																																																
$\Phi \leq 0.1$	Ignore																																																																		
$0.1 < \Phi \leq 0.2$	2(distance $\geq 10\text{mm}$)																																																																		
$0.2 < \Phi \leq 0.3$	1																																																																		
$\Phi > 0.3$	0																																																																		
Zone Size (mm)	Acceptable Qty																																																																		
	A	B	C																																																																
$\Phi \leq 0.2$	Ignore																																																																		
$0.2 < \Phi \leq 0.5$	2(distance $\geq 10\text{mm}$)																																																																		
$\Phi > 0.5$	0																																																																		

Product Specification				
		Rev. No.	Issued Date.	Page.
	Model: XTPY50SN03-02	A	2016,02,16	21 / 22

	Line defect (LCD/TP /Polarizer black/white line, scratch, stain)	<table border="1"> <thead> <tr> <th rowspan="2">Width(mm)</th> <th rowspan="2">Length(mm)</th> <th colspan="3">Acceptable Qty</th> </tr> <tr> <th>A</th> <th>B</th> <th>C</th> </tr> </thead> <tbody> <tr> <td>$\Phi \leq 0.03$</td> <td>Ignore</td> <td colspan="3">Ignore</td> </tr> <tr> <td>$0.03 < W \leq 0.05$</td> <td>$L \leq 3.0$</td> <td colspan="2">N\leq2</td> <td rowspan="2">Ignore</td> </tr> <tr> <td>$0.05 < W \leq 0.08$</td> <td>$L \leq 2.0$</td> <td colspan="2">N\leq2</td> </tr> <tr> <td>$0.08 < W$</td> <td colspan="4">Define as spot defect</td> </tr> </tbody> </table>	Width(mm)	Length(mm)	Acceptable Qty			A	B	C	$\Phi \leq 0.03$	Ignore	Ignore			$0.03 < W \leq 0.05$	$L \leq 3.0$	N \leq 2		Ignore	$0.05 < W \leq 0.08$	$L \leq 2.0$	N \leq 2		$0.08 < W$	Define as spot defect			
Width(mm)	Length(mm)	Acceptable Qty																											
		A	B	C																									
$\Phi \leq 0.03$	Ignore	Ignore																											
$0.03 < W \leq 0.05$	$L \leq 3.0$	N \leq 2		Ignore																									
$0.05 < W \leq 0.08$	$L \leq 2.0$	N \leq 2																											
$0.08 < W$	Define as spot defect																												
3.0	Polarizer Bubble	<table border="1"> <thead> <tr> <th rowspan="2">Zone Size (mm)</th> <th colspan="3">Acceptable Qty</th> </tr> <tr> <th>A</th> <th>B</th> <th>C</th> </tr> </thead> <tbody> <tr> <td>$\Phi \leq 0.2$</td> <td colspan="3">Ignore</td> </tr> <tr> <td>$0.2 < \Phi < 0.4$</td> <td colspan="3">2(distance \geq 10mm)</td> </tr> <tr> <td>$0.4 < \Phi < 0.6$</td> <td colspan="3">1</td> </tr> <tr> <td>$0.6 < \Phi$</td> <td colspan="3">0</td> </tr> </tbody> </table>	Zone Size (mm)	Acceptable Qty			A	B	C	$\Phi \leq 0.2$	Ignore			$0.2 < \Phi < 0.4$	2(distance \geq 10mm)			$0.4 < \Phi < 0.6$	1			$0.6 < \Phi$	0						
Zone Size (mm)	Acceptable Qty																												
	A	B	C																										
$\Phi \leq 0.2$	Ignore																												
$0.2 < \Phi < 0.4$	2(distance \geq 10mm)																												
$0.4 < \Phi < 0.6$	1																												
$0.6 < \Phi$	0																												
4.0	SMT	According to IPC-A-610C class II standard . Function defect and missing part are major defect ,the others are minor defect.																											

